

HD 210-TY

ALUMINIUM HORN SPEAKER WITH DRIVER AND TRANSFORMER

DESCRIPTION

The HD 210/TY are compact, lightweight and watertight horn speakers. They are designed to provide high efficiency and characterized by the high intelligibility of the reproduced sound with low distortion. The built-in line transformer makes it possible to connect the horn loudspeaker to both 50 and 100 V constant voltage lines, and select the delivered power by means of a rotary dial on the rear cover.



MAIN APPLICATIONS

- Railway stations
- Car parking
- Bathing establishment
- Stadium
- Funny resort

MAIN FEATURES

- Built-in line transformer with multitap power selector on rear cover.
- Hi-pass filter for protecting driver against out-of-range low-freq.
- IP 66 construction for indoor-outdoor environmental temperature between -25°C to +70°C.
- Aluminum flare with UV-stabilized auto-extinguishing UL-HB ABS rear cover.
- Color RAL 7035.
- Stainless-steel mounting bracket with high resistance to vibration, particularly suitable for railway applications.
- Double insulation design.

SPECIFICATIONS

| | |
|-------------------------|---|
| Loudspeaker | Round, with driver unit and transformer |
| Power (on 8 Ohm load) | 20 / 30 W (RMS / Music power) |
| Power | 20 W - 10 W - 5 W - 2.5 W (100V) |
| Sensitivity | 108 dB (1 W / 1 m) |
| Mx. SPL | 123 dB(A) (1 m / POWER MAX) |
| Frequency Response | 300 Hz - 9 kHz |
| Angle of coverage | 70° |
| Thermal protection | circuit breaker on the line transformer (110°C) |
| Insulation voltage | 6 kV |
| Connector | 2 conductor cable |
| Body colour | Grey RAL 7035 |
| Main body material | Aluminium |
| Connection cable length | 1 meter |
| Dimensions | Ø 212 mm x 290 mm |
| Installation | "U" Bracket stainless steel |
| Max wall distance | 40 mm |
| Net weight | 2.4 kg |
| Operating temperature | -25° to +70° |
| Relative humidity | 90% non condensing |

HD 210-TY

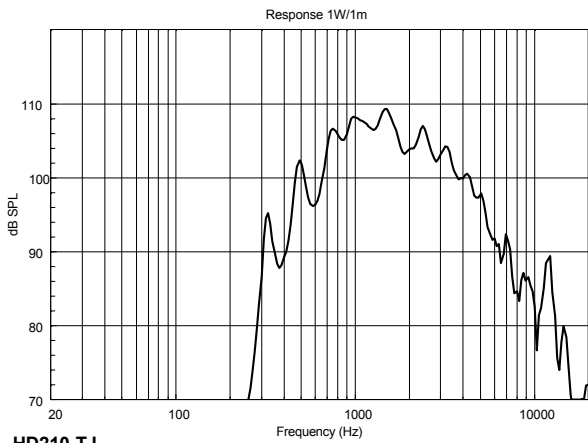

HD210-TJ

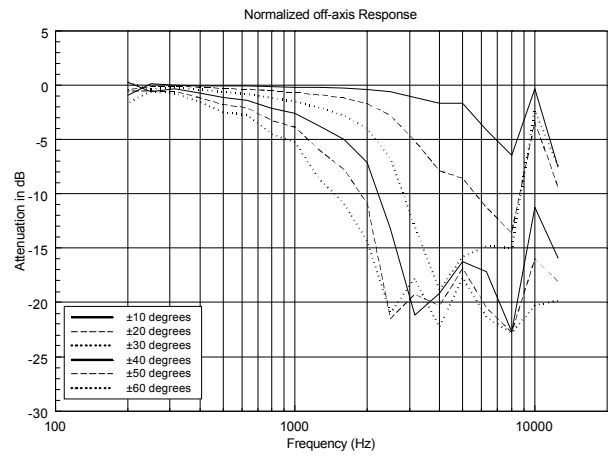
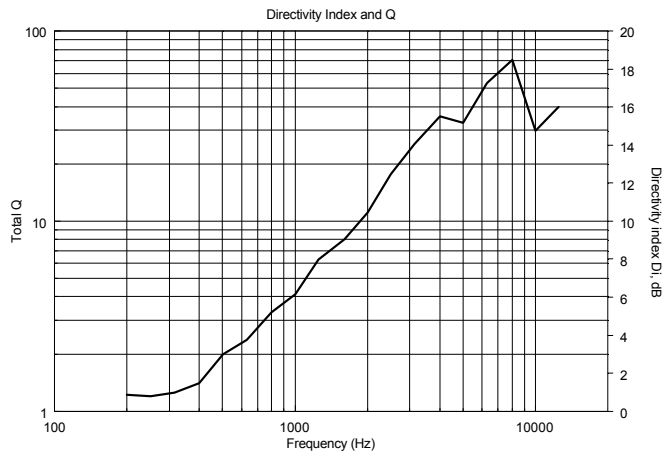
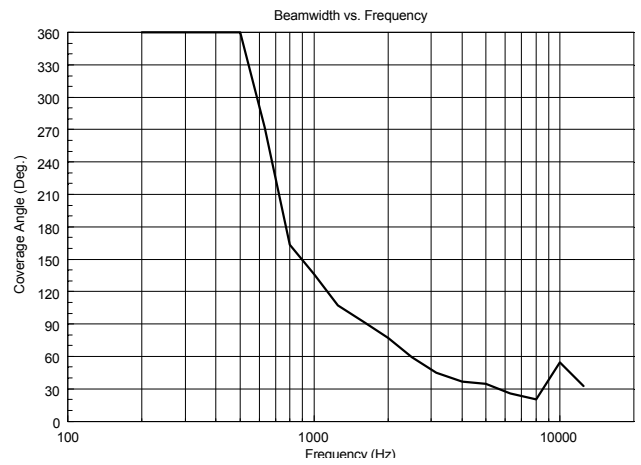

HD 210-TY

HORIZONTAL 1/3 POLAR PLOT

1/3 Octave Polars

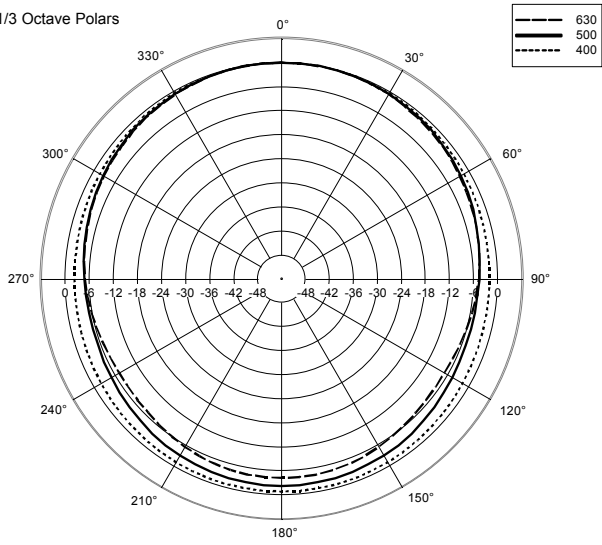

1/3 Octave Polars

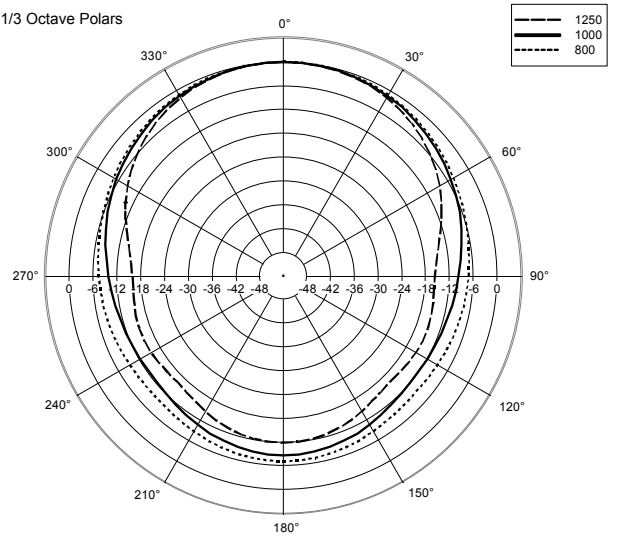

1/3 Octave Polars

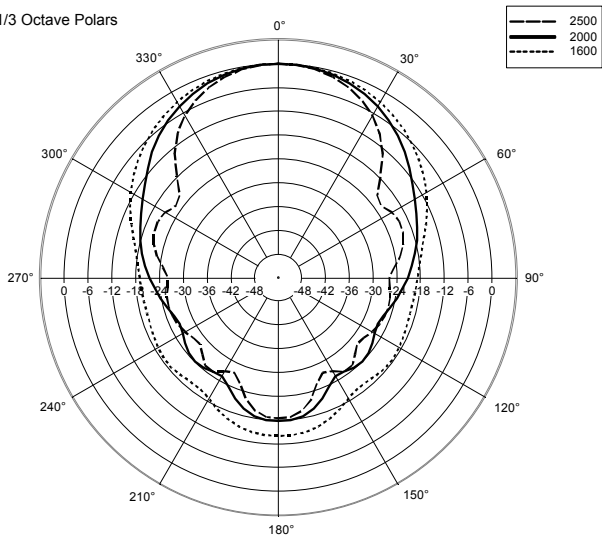

1/3 Octave Polars

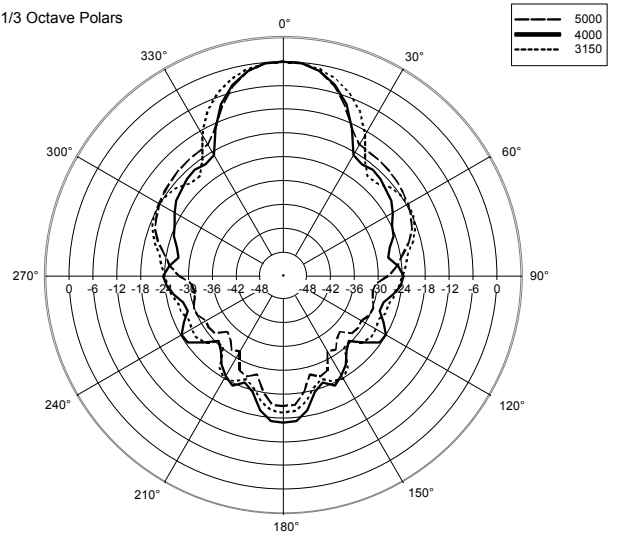

HD 210-TY

PART NUMBERS

0007057

DIMENSIONS (All data are in mm)

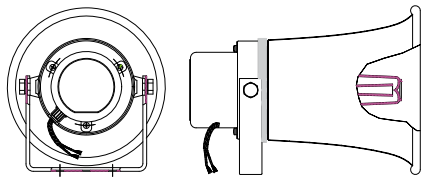

SCHEMATICS

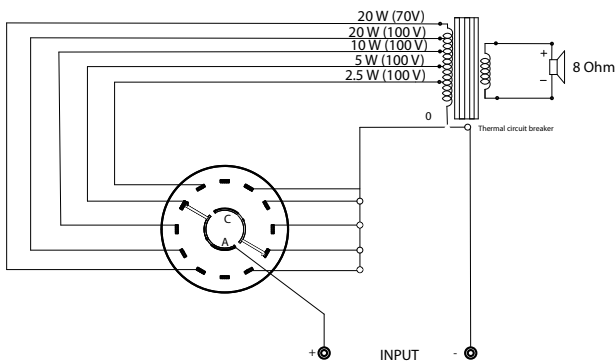

POWER SELECTION

Set the rotary switch to selected the chosen power value (2.5 W – 5 W – 10 W – 20 W) referring to either the 100 V or 70 V line.

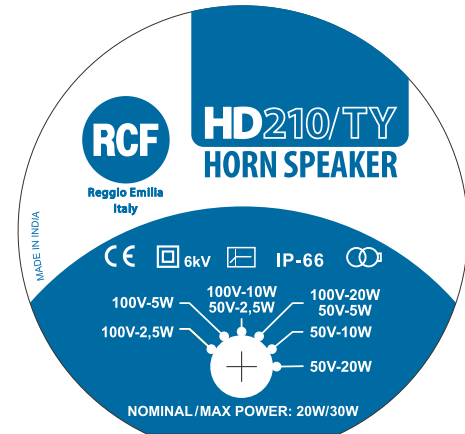

CERTIFICATIONS AND APPROVALS

- CE: it complies with European Community 73/23/EEC and 93/768/EEC
- Self-extinguishing plastic according to UL 94V0
- IP rating: 66
- Speaker data according to IEC 268-5
- Electronic apparatus safety requirements according to IEC EN 60065:2002.
- Vibration resistance according with IEC 61373 (Railway applications – Rolling stock equipment – Shock and vibration tests)

INSTALLATION NOTES

HD 210-TY installation is quick thanks to its 'U' bracket, which can be fixed to the wall / ceiling through the holes on its base. The horn loudspeaker can be aimed to any direction.

The mounting bracket, the bracket holder and the horn flare are made of aluminum and screws, bolts and nuts are made of stainless steel.

The rear cover is made of high density UV resistant self-extinguishing polystyrene.

ACCESSORIES (included)

- U Bracket stainless steel