

# DM 41

## COMPACT 2 WAY LOUDSPEAKER



### DESCRIPTION

DM 41 is a compact two-way loudspeaker designed for public address systems. It provides natural and smooth sound reproduction, ideal for background music and paging as well. It has a transformer inside that allows its connection to a 70 – 100 V constant voltage line. When connected to a 100 V line, its power can be selected among the values 15 W, 10 W, 5 W or 2.5 W through a rotary switch (thanks to the internal transformer taps). DM 41 can be connected to either a 100 V constant voltage line or a low impedance amplifier output. The enclosure has a protective perforated grille. Its wall-mount accessory is included.

### MAIN APPLICATIONS

- Background music systems
- Audio visual systems
- Pubs
- Hotels
- Shopping Malls
- Restaurants
- Offices

### MAIN FEATURES

- 3.5" woofer (Mylar), 1" dome tweeter
- Power: 15 W RMS
- Frequency response: 100 Hz ÷ 20 kHz
- Max. sound pressure level: 99 dB (15 W, 1 m)
- 70 – 100 V multi-tap transformer included
- Easy to install
- Simple power settings

### SPECIFICATIONS

Loudspeaker	Woofer 3.5" mylar, 1" tweeter
Power (on 8 Ohm load)	15 / 30 W (RMS / Music power)
Power	15 W - 10 W - 5 W - 2.5 W (100V)
Sensitivity	87 dB (1 W / 1 m)
Max. SPL (30 W / 1 m)	102 dB(A)
Frequency Response	100 Hz – 20 kHz
Low impedance input setting:	8 Ω
Angle of coverage	180° / 120° / 90° @ 1 / 2 / 4 kHz
Connector	2 conductor cable
Body colour	White Ivory RAL 9002
Main body material	Auto-extinguishing high-density polystyrene
Grill material	Steel
Dimensions (HxWxD)	130 mm x 197 mm x 115 mm
Installation	Aluminium U bracket
Max ceiling thickness	35 mm
Net weight	1.8 kg
Operating temperature	-25° to +55°
Relative humidity	90% non condensing

# DM 41

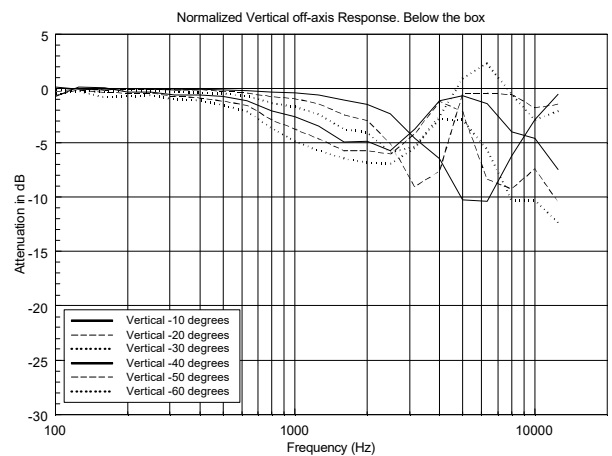
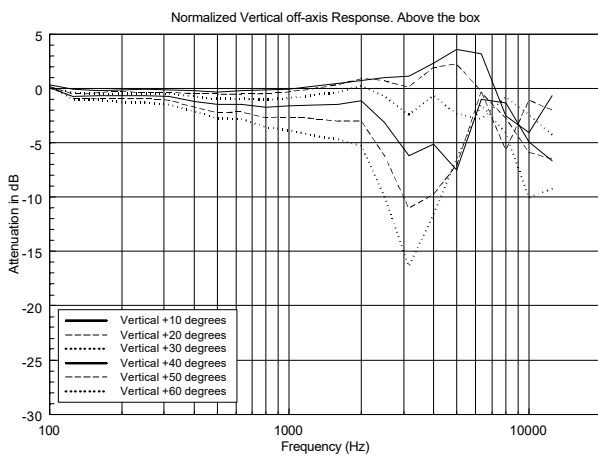
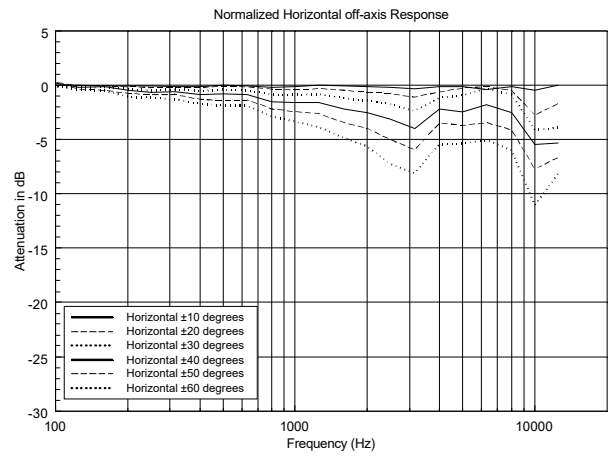
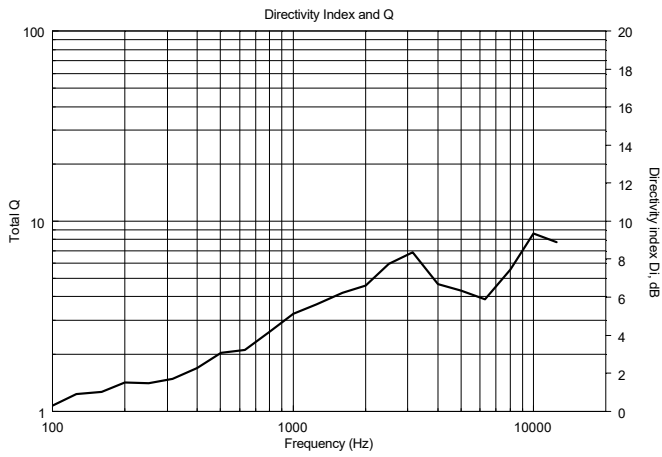
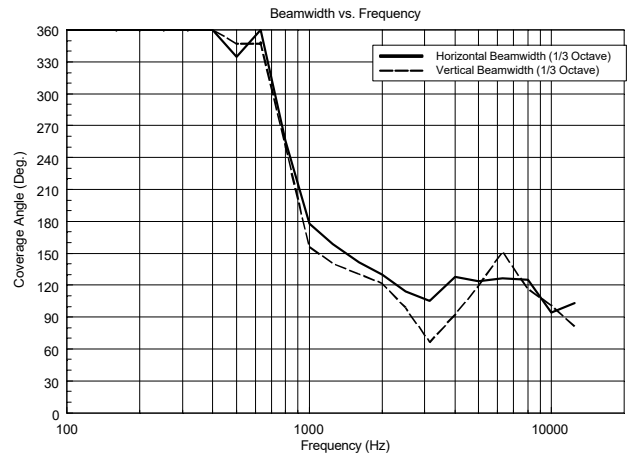
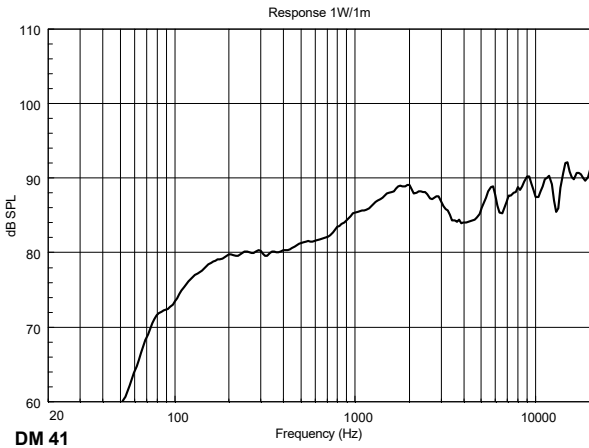

# DM 41

## HORIZONTAL 1/3 POLAR PLOT

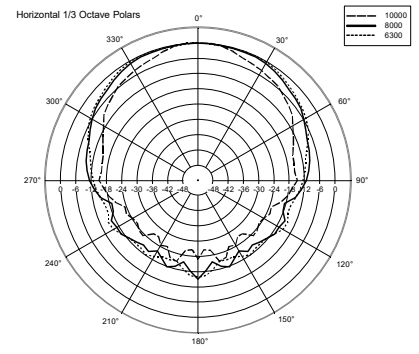
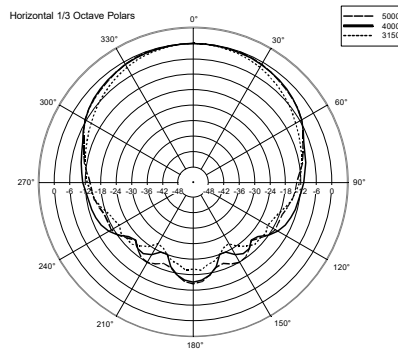
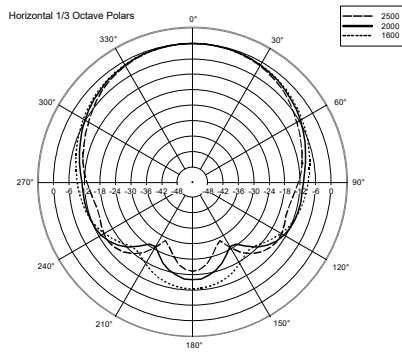
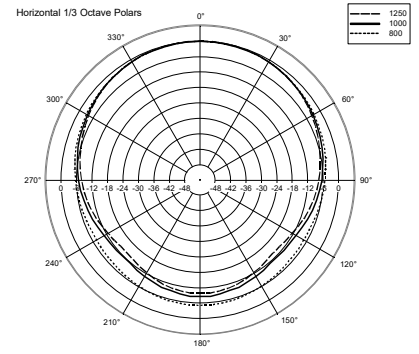
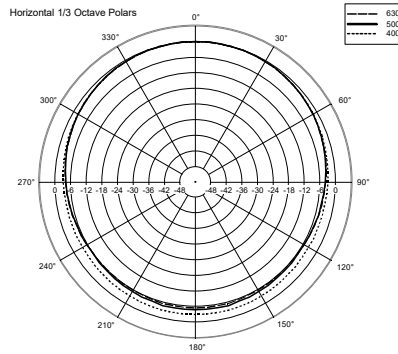
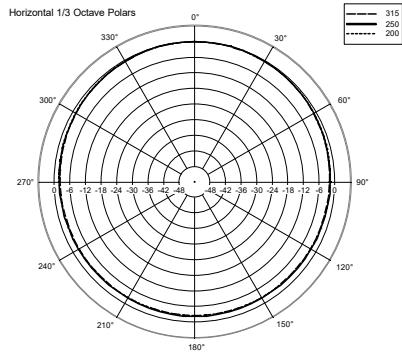

## VERTICAL 1/3 POLAR PLOT

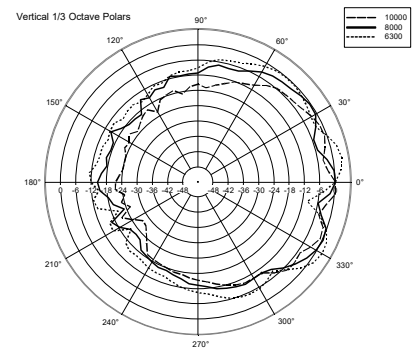
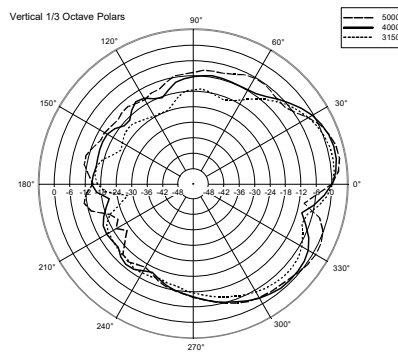
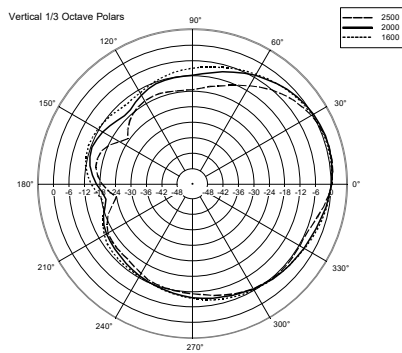
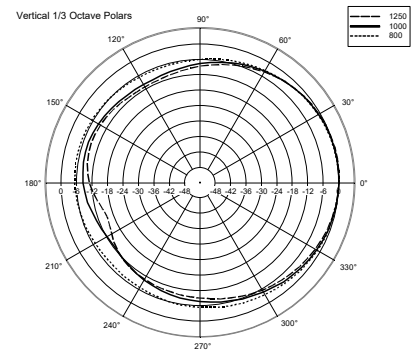
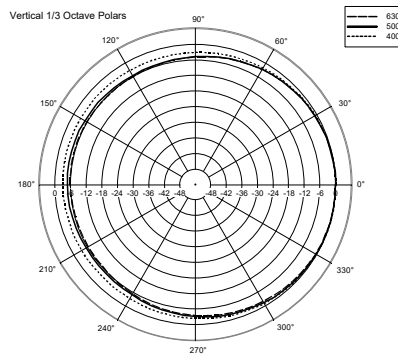
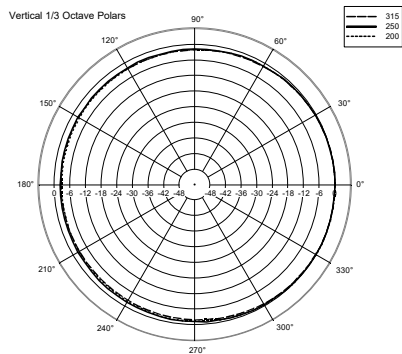

# DM 41

## PART NUMBERS

13000049

## DIMENSIONS (All data are in mm)

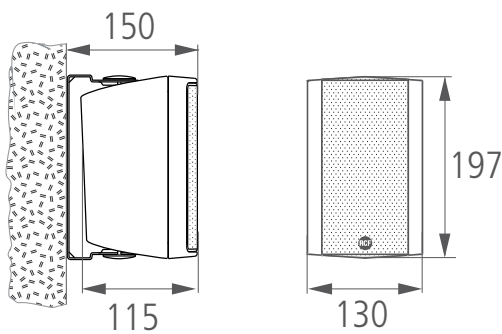

## SCHEMATICS

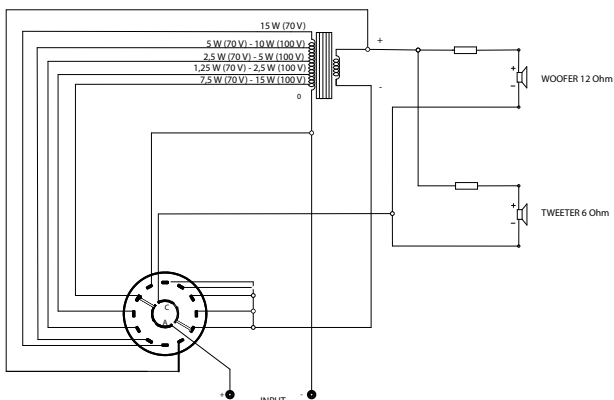

## INSTALLATION NOTES

Installation of the DM 41 is quick and easy thanks to its wall-mount U bracket.

Its connection to the constant voltage loudspeaker line is made through the two-wire cable coming out from the loudspeaker rear side.

The power can be easily set by using its rotary switch on the loudspeaker back side.

The enclosure is made of high density UV resistant self-extinguishing polystyrene with a robust steel grille.

The DM 41 model can be installed both indoor and outdoor.

## POWER SELECTION

Set the rotary switch to the chosen power value for 100V connection (with 70V line power will be halved), or to low impedance position (8 ohm).

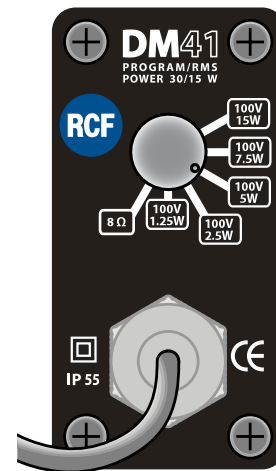

## CERTIFICATIONS AND APPROVALS

- CE: it complies with European Community 73/23/EEC and 93/768/EEC
- Self-extinguishing plastic according to UL 94V0
- IP rating: 55
- Speaker data according to IEC 268-5
- Electronic apparatus safety requirements according to IEC EN 60065:2002

## ACCESSORIES (included)

- Wall-mount U bracket