

BS 8

SUSPENDED SPEAKER

DESCRIPTION

The BS 8 is a spherical speaker designed for suspended installation. Ideal for covering large areas, it incorporates a 200 mm (8") loudspeaker which provides high quality sound reproduction with excellent voice intelligibility.



FEATURES

- Pendant speaker
- For paging and background music
- 8" diameter dual cone wide band speaker
- Plastic body - White RAL 9010
- Built-in transformer for 100V constant voltage connection
- 5-metre suspension and connection cable included

TECHNICAL SPECIFICATIONS

Acoustical specifications	Frequency Response (-10dB):	160 Hz ÷ 12500 Hz
	Max SPL @ 1m:	106 dB
	Horizontal coverage angle:	360°
	System Sensitivity:	93 dB
Power section	Power Handling:	20 W RMS
	Peak Power Handling:	80 W PEAK
	Recommended Amplifier:	40 W
Transducers	Woofers:	8"
Input/Output section	Input connectors:	Cable
	Output connectors:	Cable
	Constant Voltage Transformer:	100 V
	Power selection 1 (100 V):	20 W - 500 ohm
	Power selection 2 (100 V):	10 W - 1000 ohm
	Power selection 3 (100 V):	5 W - 2000 ohm
Standard compliance	CE marking:	Yes
Physical specifications	Cabinet/Case Material:	Plastic
	Hardware:	Carabiner and safety steel wire
	Grille:	Plastic
	Color:	White - RAL 9010
Size	Height:	240 mm / 9.45 inches
	Diameter:	250 mm / 9.84 inches
	Weight:	2.3 kg / 5.07 lbs
Shipping informations	Package Height:	300 mm / 11.81 inches
	Package Width:	315 mm / 12.4 inches
	Package Depth:	315 mm / 12.4 inches
	Package Weight:	3.55 kg / 7.83 lbs

PART NUMBER

- **13133054**

BS 8

EAN 8024530005733

DRAWINGS

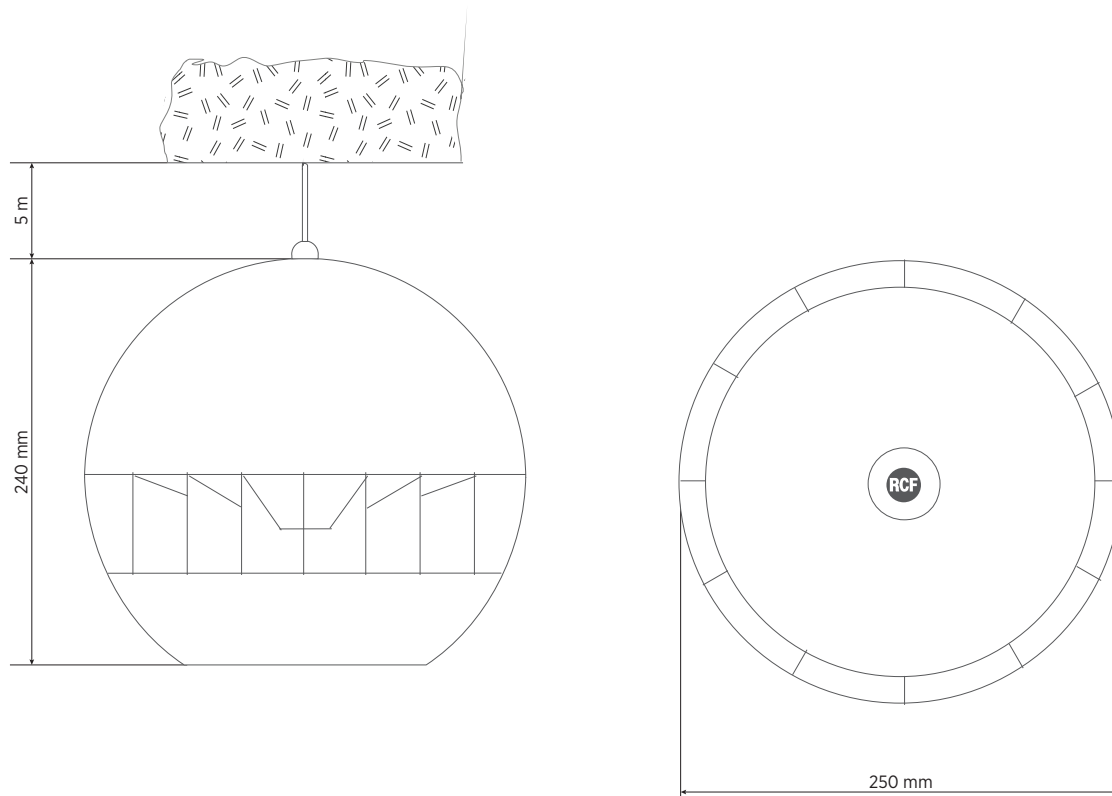

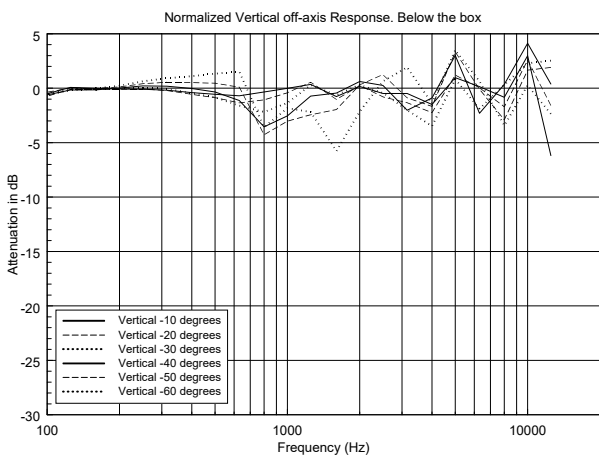
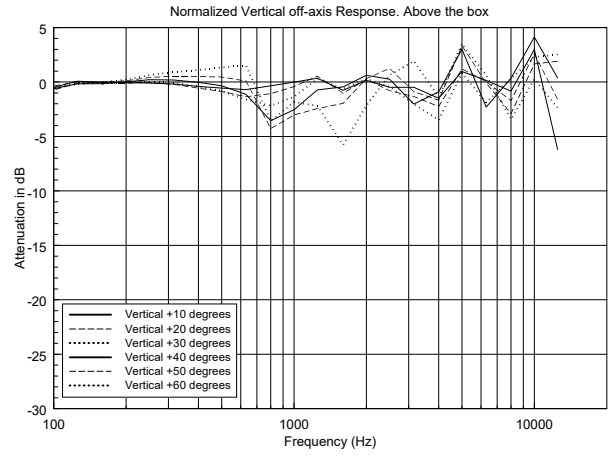
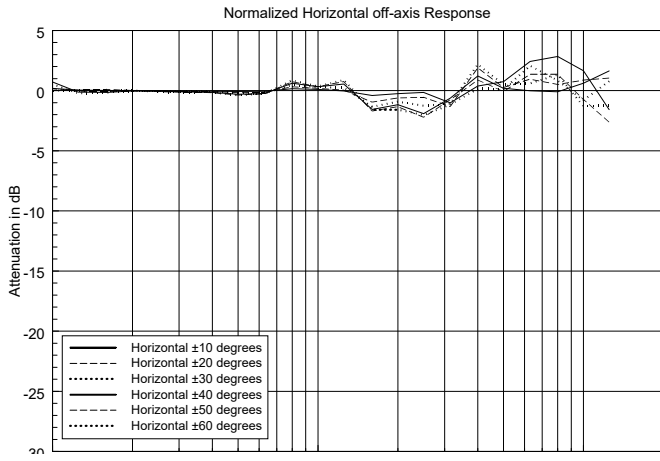
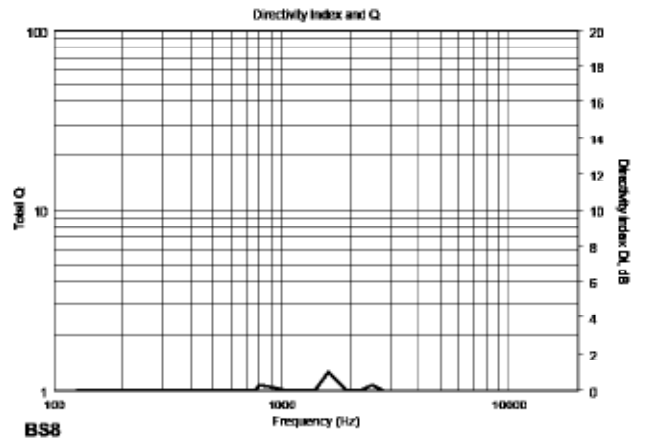
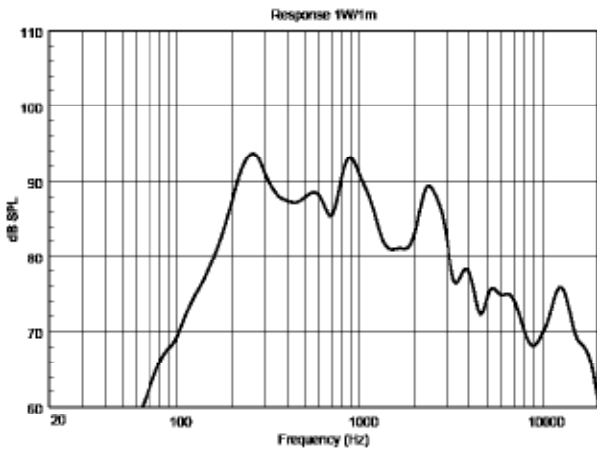

HORIZONTAL 1/3 POLAR PLOT

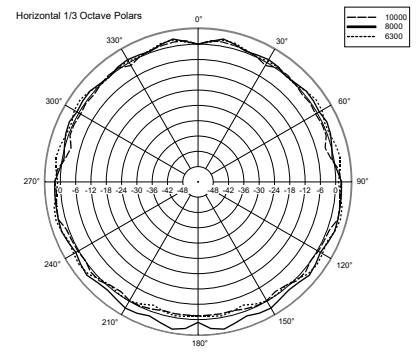
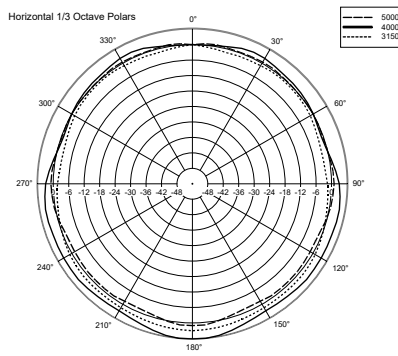
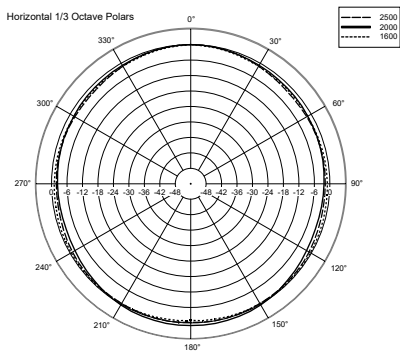
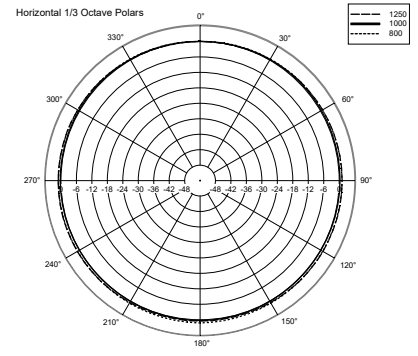
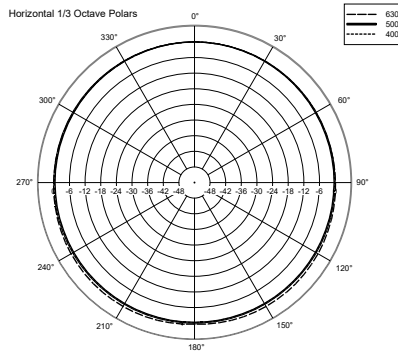
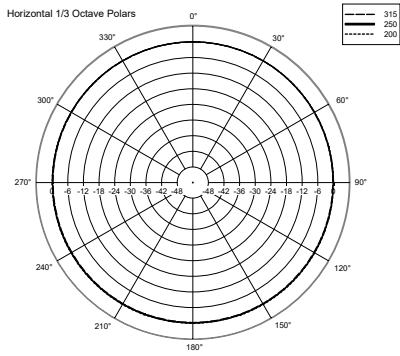

VERTICAL 1/3 POLAR PLOT

